

Sectional Views Exercise 3

In first angle orthographic projection, complete a sectional:

- a) **Plan view** on the cutting plane X-X.

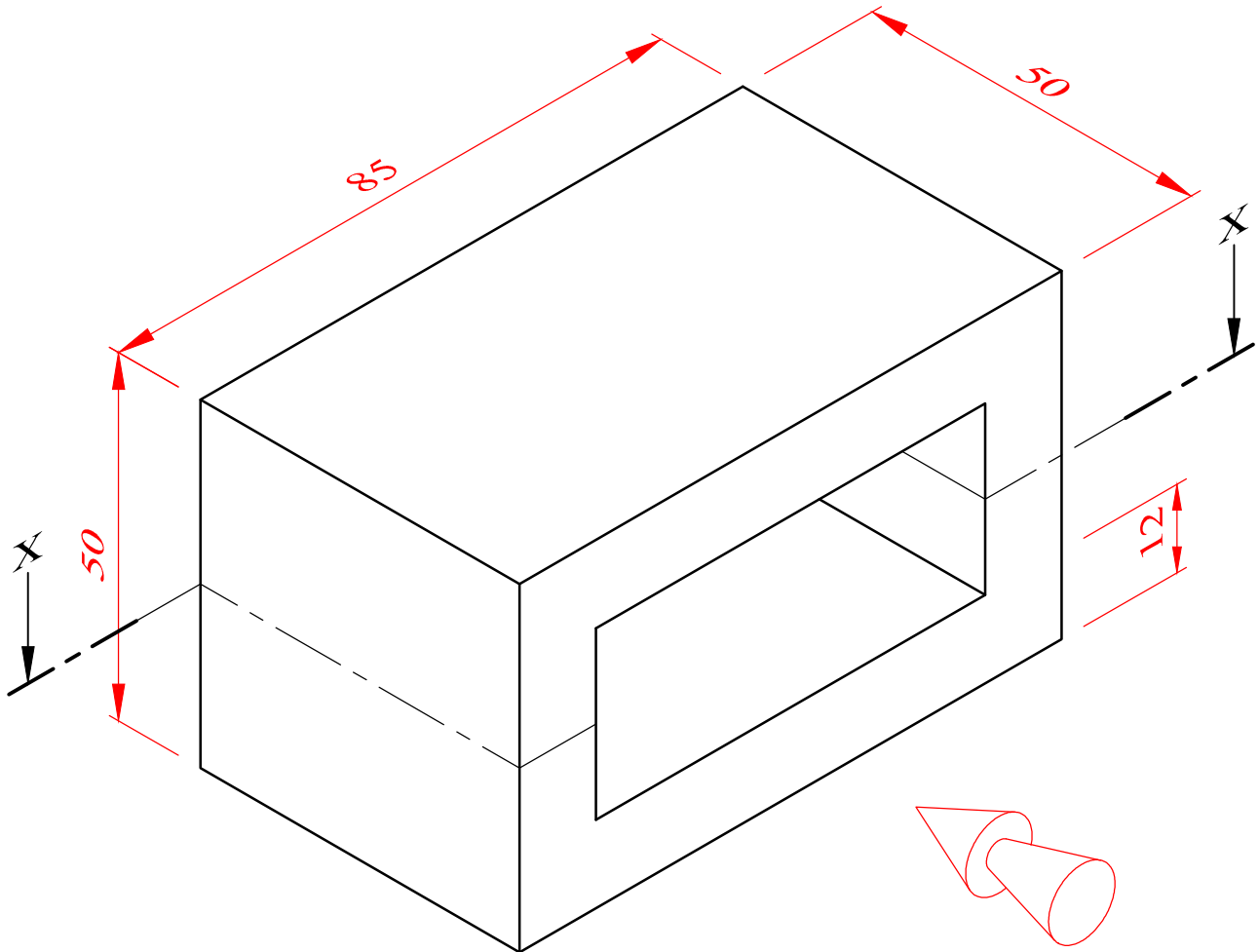

FRONT ELEVATION

If you have difficulty placing the views and spacing them neatly, you can use the starter sheet provided to help you. As you improve, try completing the drawing without the use of the starter sheet.

To help you visualize the object better you can visit:

<https://youtu.be/Kpkhexz0j1E> for a video of the object rotating in space.

Sectional Views Exercise 3 - STARTER SHEET

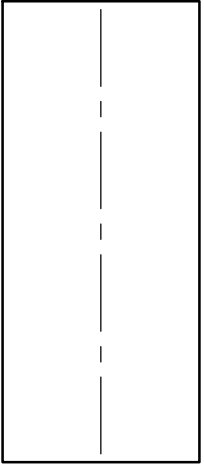
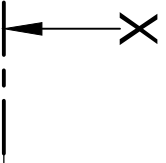

FRONT VIEW

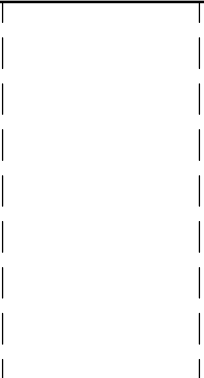
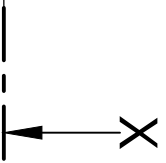

END VIEW

SECTIONAL PLAN X-X

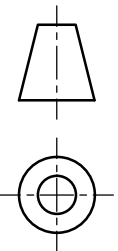
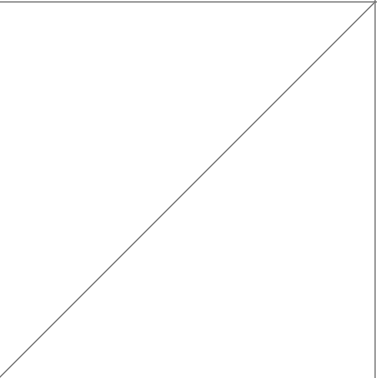

Sectional Views Exercise 3 - ANSWER

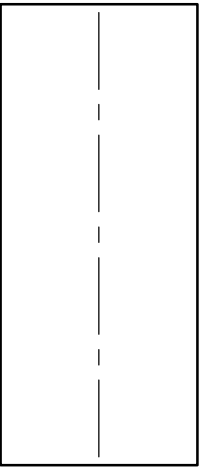
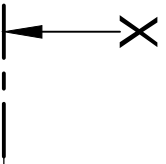

FRONT VIEW

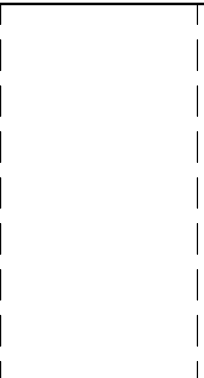
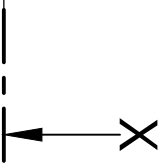

END VIEW

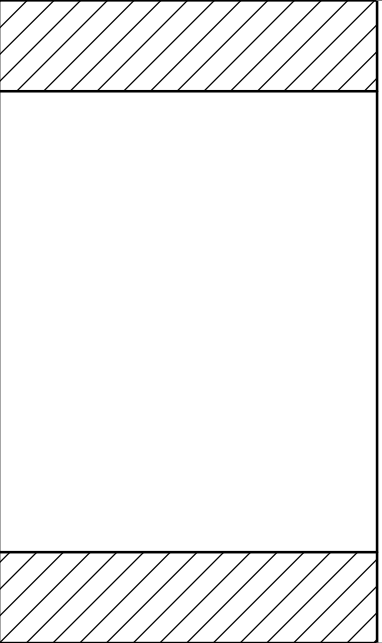

SECTIONAL PLAN X-X

