

Third Angle Projection Exercise 12

In third angle orthographic projection, draw the:

- a) **Front view** from the direction of the arrow shown,
- b) **End view** and
- c) **Plan**
- d) **Third Angle** symbol

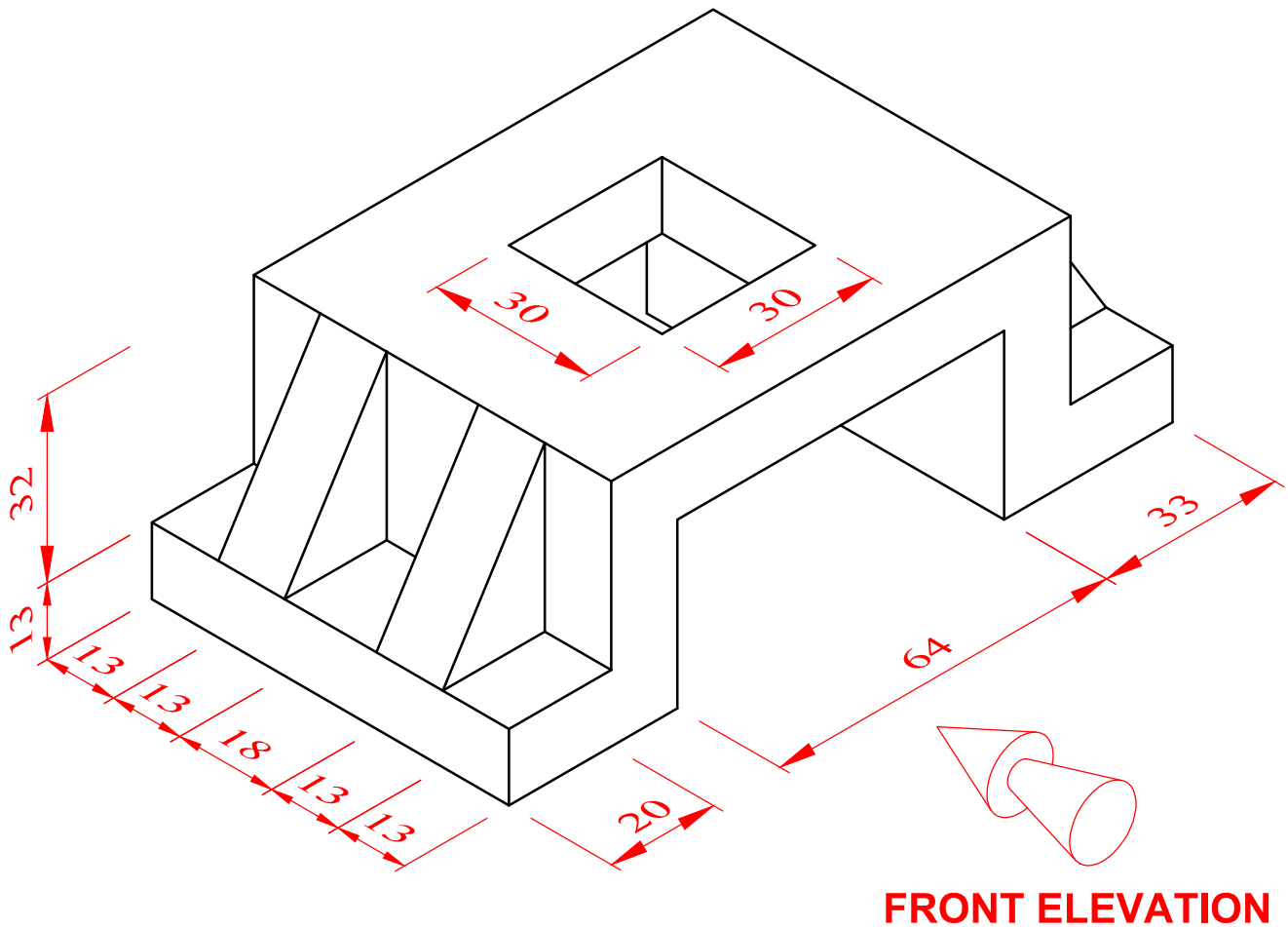

FRONT ELEVATION

If you have difficulty placing the views and spacing them neatly, you can use the starter sheet provided to help you. As you improve, try completing the drawing without the use of the starter sheet.

To help you visualize the object better you can visit:

<https://youtu.be/nwlpqAvVUk> for a video of the object rotating in space.

Third Angle Projection Exercise 12 - STARTER SHEET

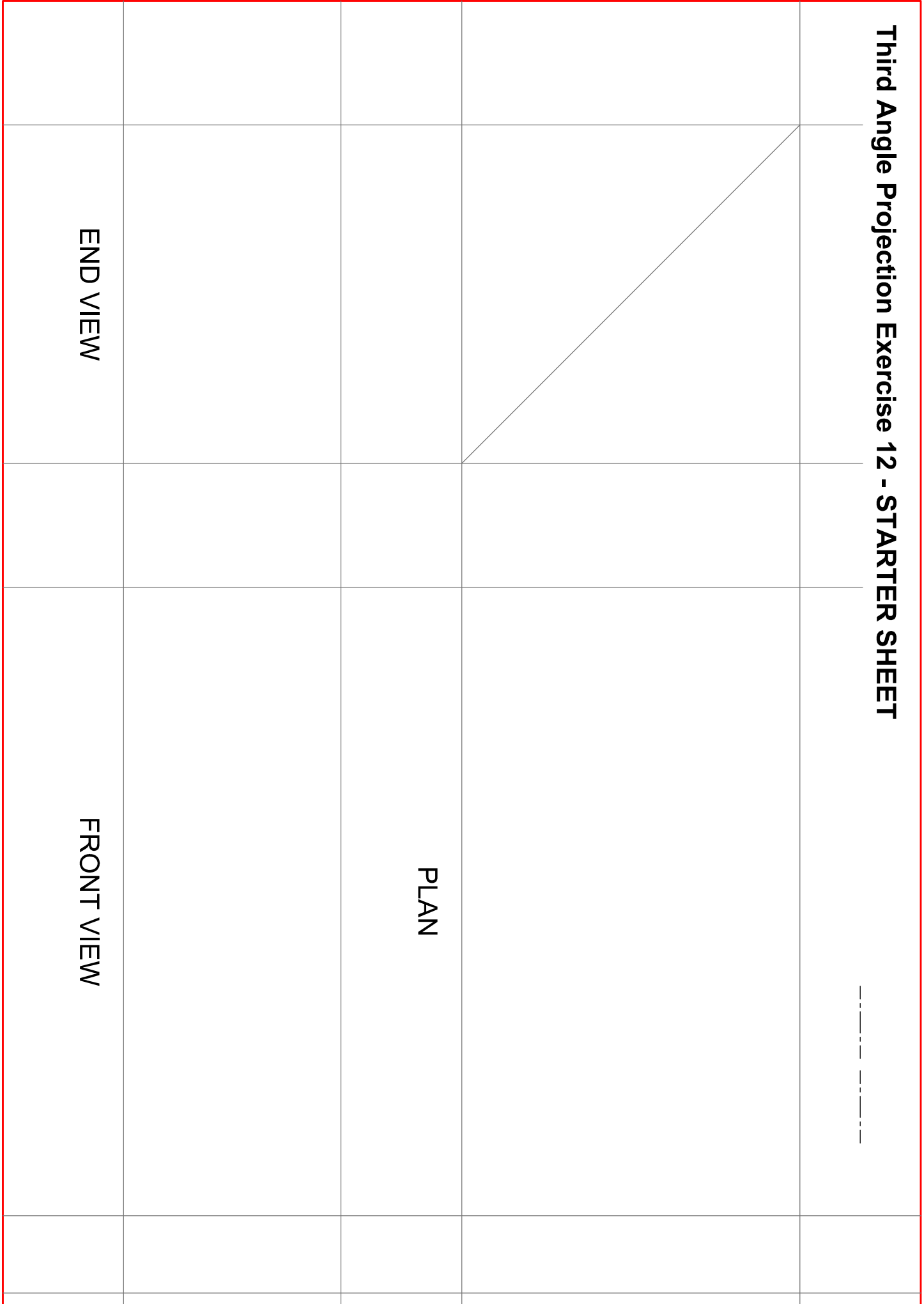

Third Angle Projection Exercise 12 - ANSWER

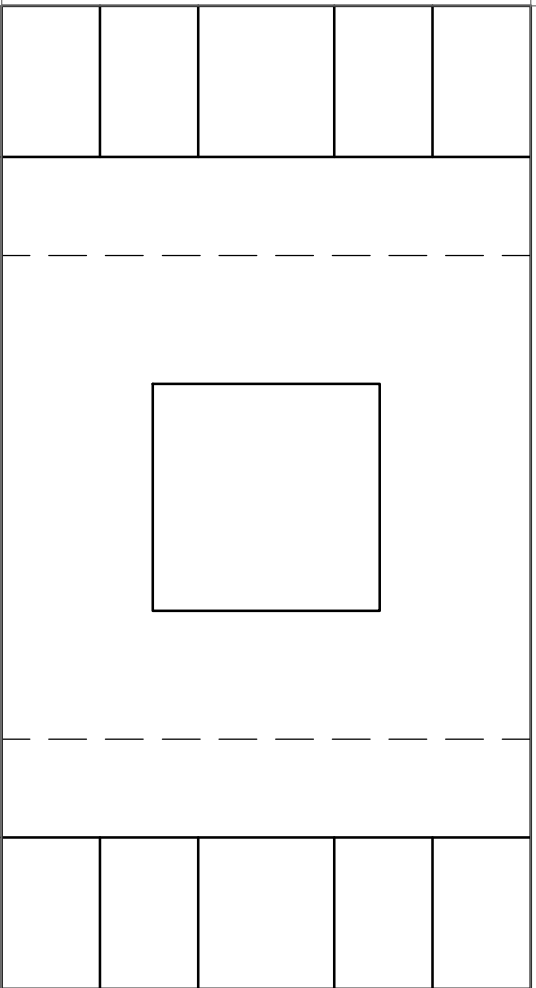
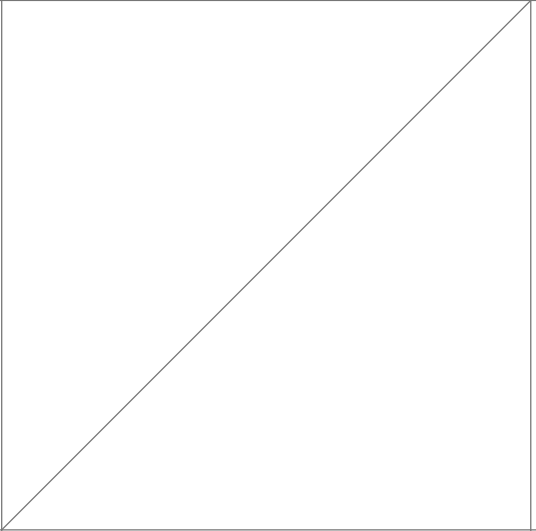
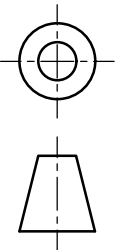

PLAN

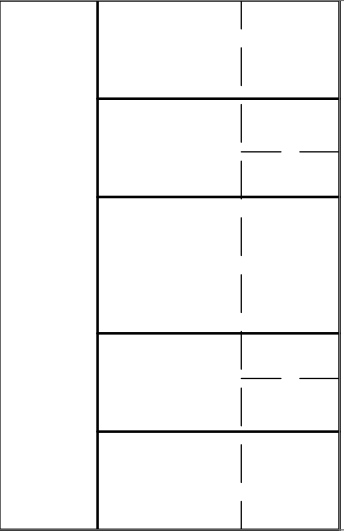

END VIEW

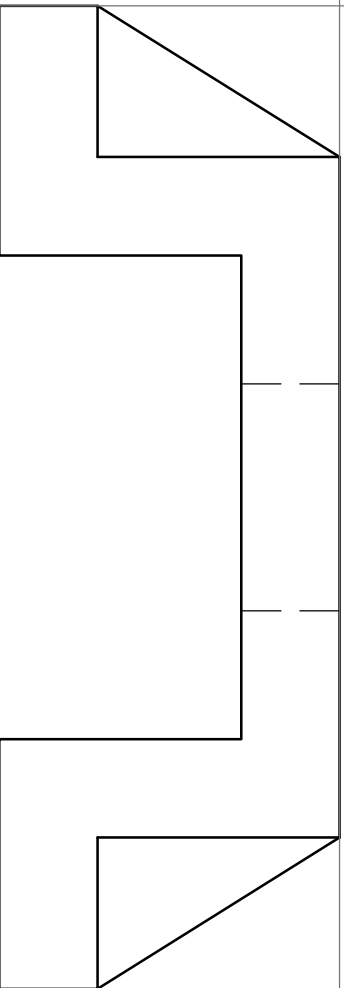

FRONT VIEW